

20-LTS244

4 Gang 400W Intelligent Dimmer - Traditional Plate

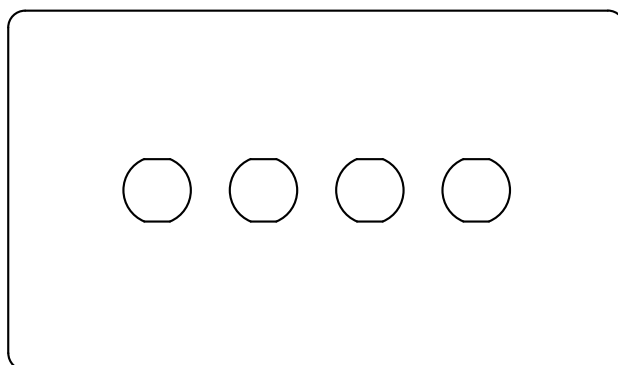

20-GRD136

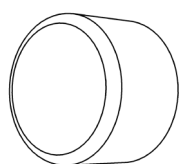

SGP146

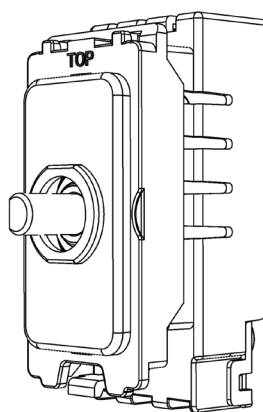

Enkin PDM400 & SOHO Grid Adapter

Contents

20-GRD136	4 Gang Circular Hole Grid Plate - Traditional
	<ul style="list-style-type: none"> — 20-PLT136 4 Gang Circular Hole Traditional Grid Plate — 20-EDG008 Double Traditional Type Gasket — SGPYLK-34 Double Grid Frame (Yoke)
SGP146	CM-Grid Dimmer Knob X 4
Enkin PDM400	400W Intelligent Dimmer with Soho CM Grid Adapter X 4
Trademarks	The Soho Lighting Company is a registered trade mark number: UK00003313349, EU017906396, Date: 25 May 2018

POWERED BY
E N K I N

20-GRD132-139

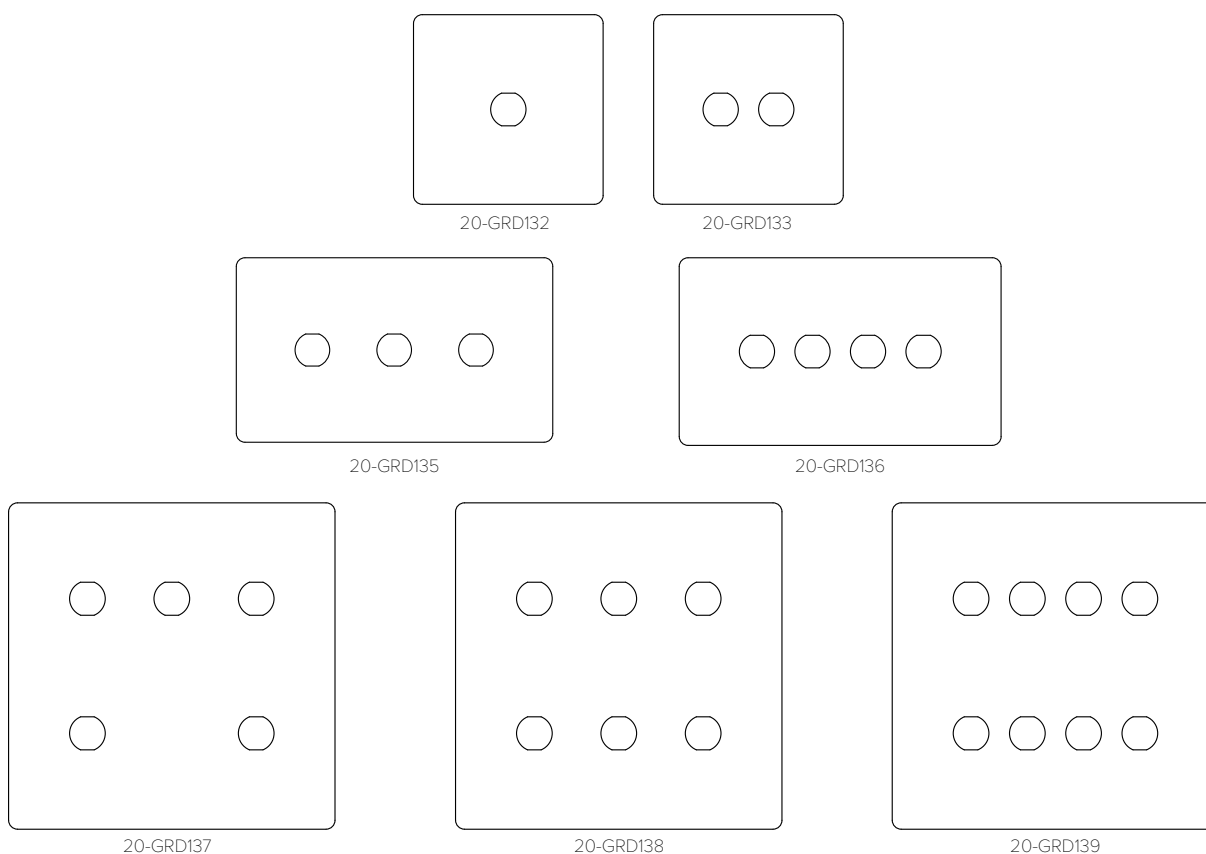

TECHNICAL SPECIFICATION

Standard(s)	BS 5733 (Where Applicable)
Mounting Box Depth (Recommended)	47mm
Earth Terminal Capacity	3 x 2.5mm ² , 2 x 4.0mm ² , 1 x 6.0mm ² (EARTH)
Fixing Centres	60.3mm (Single width) 120.6mm (Double Width)
Size - (1 Gang) 20-GRD132	86mm x 86mm x 4.5mm (Plate Thickness Inc. Gasket)
Size - (2 Gang) 20-GRD133	86mm x 86mm x 4.5mm (Plate Thickness Inc. Gasket)
Size - (3 Gang) 20-GRD135	86mm x 146mm x 4.5mm (Plate Thickness Inc. Gasket)
Size - (4 Gang) 20-GRD136	86mm x 146mm x 4.5mm (Plate Thickness Inc. Gasket)
Size - (5 Gang) 20-GRD137	146mm x 146mm x 4.5mm (Plate Thickness Inc. Gasket)
Size - (6 Gang) 20-GRD138	146mm x 146mm x 4.5mm (Plate Thickness Inc. Gasket)
Size - (8 Gang) 20-GRD139	146mm x 146mm x 4.5mm (Plate Thickness Inc. Gasket)
Product Class 1	Face plate must be earthed
Ambient Operating Temperature	-5° to +40°C
Recommended Location	Internal Use Only
Maximum Installation Altitude	2000m
IP Rating	IP2XD
Trademarks	The Soho Lighting Company is a registered trade mark number: UK00003313349, EU017906396, Date: 25 May 2018

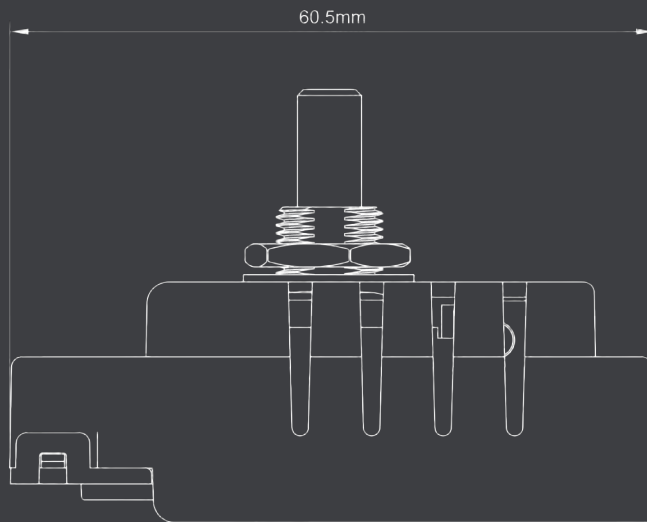
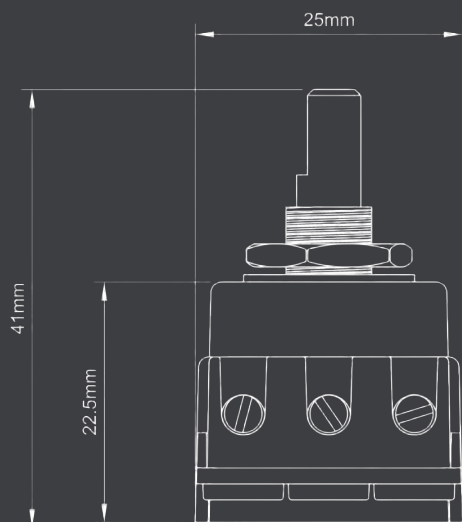

Markings & Standard(s)	CE, UKCA, BS EN 60669-2-1
Operating Voltage	220-240V AC
Main Frequency	50Hz
Minimum Load	2W LED (2W Incandescent/Halogen)
Maximum Load	400W LED (400W Incandescent/Halogen)
Switch Type	Two Way
Dimming Protocol	Trailing edge & Leading Edge Phase Control
Mounting Box Depth (Min)	35mm
Terminal Capacity	1 x 4mm ² / 1 x 2.5mm ² / 3 x 1.5mm ² / 4 x 1mm ²
Terminal Markings	C (Live), L1 (Switched Live), L2 (2-way)
Neutral Required	No
Short Circuit Protection	Yes
Overload/Overcurrent Protection	Yes
Thermal Protection	Yes - Thermal resettable fuse
Soft Start	Yes
Power Failure	Previous State Recall
Memory	Non Volatile
Min/Max Level Setting	Yes - Following a defined procedure
Driving Mode	Yes - TE & LE Mode Change Following a defined procedure
Product Dimensions	60.5mm x 14mm x 25mm
Climate Range	0°C to 40°C, Humidity 0% to 95% non-condensing
Recommended Location	Indoor Use Only
Maximum Installation Altitude	2000m
IP Rating	IP2XD
Trademarks	Enkin is a trading name of Trade Ivy. Registered in England Number: 10809945. Copyright © 2021



Operating Voltage	240V ac
Nominal Operating Frequency	50 Hz
Dimming Technique	Trailing & Leading edge phase control
Compliance	BS EN 60669-2-1

Load Symbol	Compatible Loads	Max Load	Min Load
	Dimmable LED lighting	400W TE 150W LE	2W
	240V Incandescent & Halogen lamps	400W TE 150W LE	2W
	Low voltage lighting with electronic transformers	400W TE 150W LE	2W

Multi-Gang Switch De-Rating Chart - LED Lighting				
1 Gang	2 Gang	3 Gang	4 Gang	5 Gang
400W	340W	280W	220W	160W

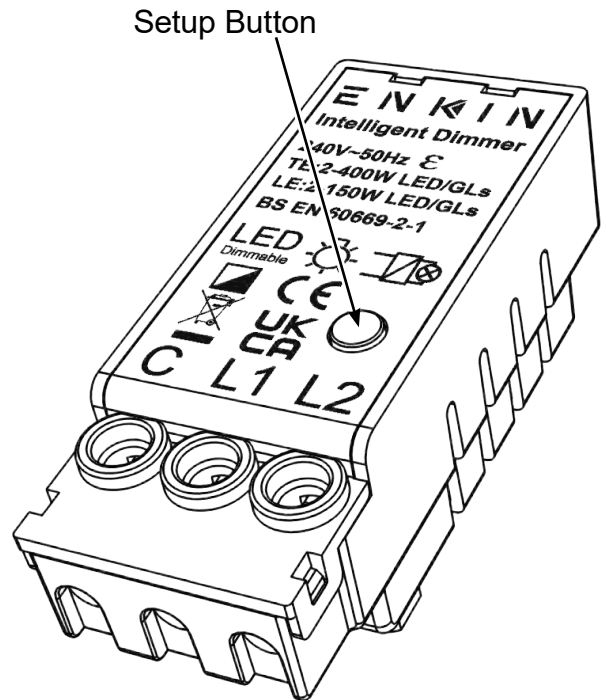

WIRING EXAMPLES

WIRING DIAGRAM - ONE WAY

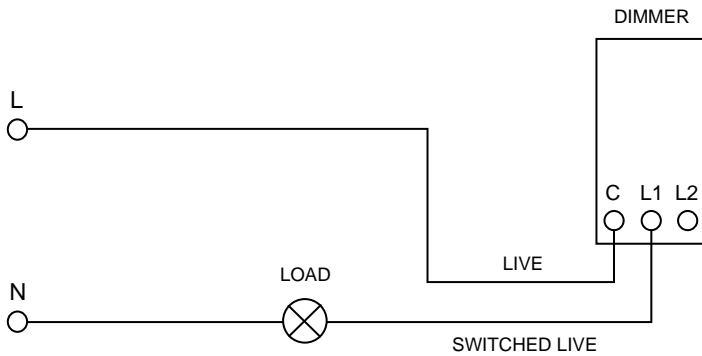

WIRING DIAGRAM - TWO WAY

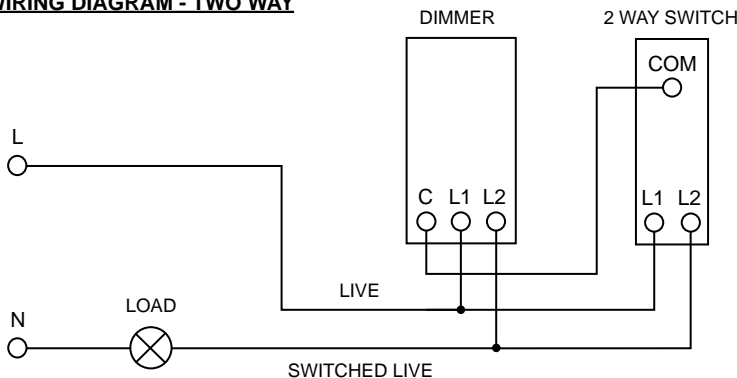

OPERATING INSTRUCTIONS

ON OFF & DIMMING FUNCTION

Dimmer switch is activated by pressing the dimmer shaft only, dimming function by rotating the dimmer shaft only.

REAR PANEL PRESS BUTTON - DIMMER SETUP SEQUENCES

Setting the Minimum Level

1. Whilst on, slowly adjust dimmer to your desired minimum brightness.
2. Push the rear setup button 3 times within 2 seconds.
3. The LEDs will step up and down in brightness once to confirm the setting has been saved.

Setting the Maximum Level

1. Whilst on, slowly adjust dimmer to your desired maximum brightness.
2. Push the rear setup button 5 times within 3 seconds.
3. The LEDs will step up and down in brightness once to confirm the setting has been saved.

Factory reset for Min/Max brightness

Please note this factory reset will reset all the min and max brightness settings.

1. Whilst on, push the rear setup button 7 times within 5 seconds.
2. The LEDs will step up and down in brightness three times to confirm that the min/max setting has been cleared.

Changing the Dimming Mode

The default mode of the dimmer is Trailing Edge, but it can be put into Leading Edge if required. Please ensure that you know the correct mode for your lamp.

1. Whilst on, push the rear setup button 9 times within 5 seconds.
2. The LEDs will step up and down in brightness twice to confirm the setting has been changed to Leading Edge mode.

NOTE:

To switch back to Trailing Edge mode, just repeat the process again, the LEDs will step up and down once to show the dimmer is back in Trailing Edge mode.

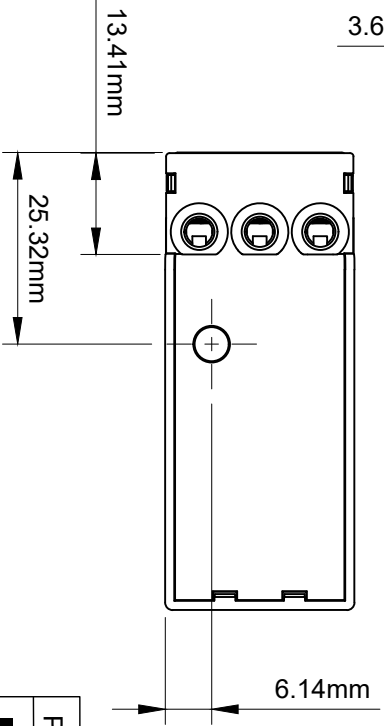
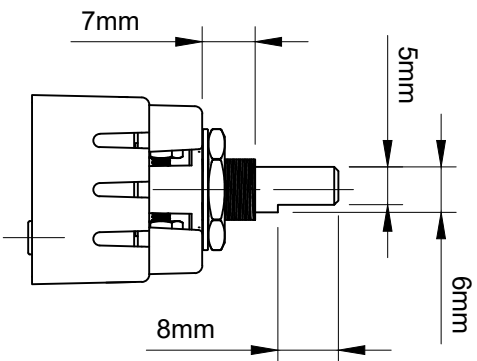
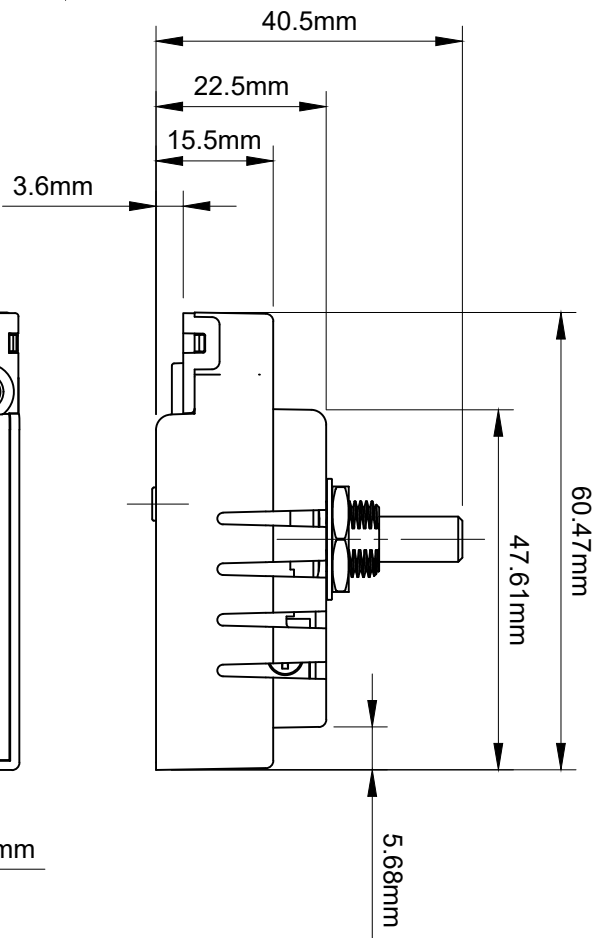
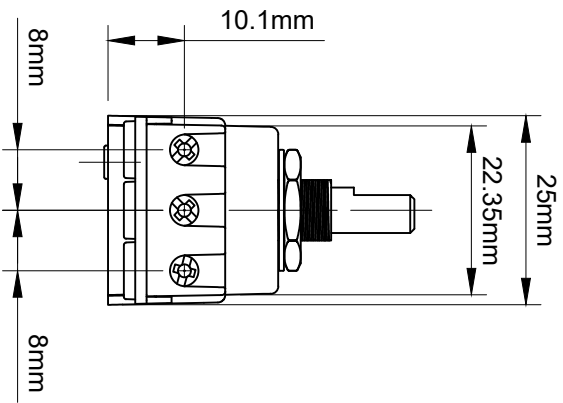
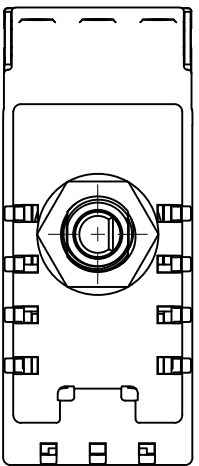

PDM400 400W LED Intelligent Dimmer

E N K I N