

INSTRUCTIONS

LT-SH-10-WLT401/402 (all finishes)

Bulb Fitting: E27, Max. 40W, 220-240V~50Hz

IMPORTANT! Please read these instructions fully before attempting to fit this product.

WARNING: ENSURE THE ELECTRICAL SUPPLY TO THE WIRES YOU ARE WORKING ON IS SHUT OFF COMPLETELY; EITHER BY REMOVING THE FUSE OR TURNING OFF THE CIRCUIT BREAKER. TURNING THE POWER OFF USING THE LIGHT SWITCH IS INSUFFICIENT PROTECTION AGAINST ELECTRIC SHOCK.

NOTE: These important safeguards and instructions are not meant to cover all possible conditions or situations that may occur. It must be understood that common sense, caution and care, are factors that must be supplied by the person(s) installing this product.

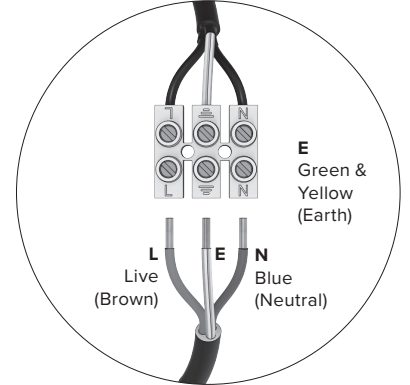
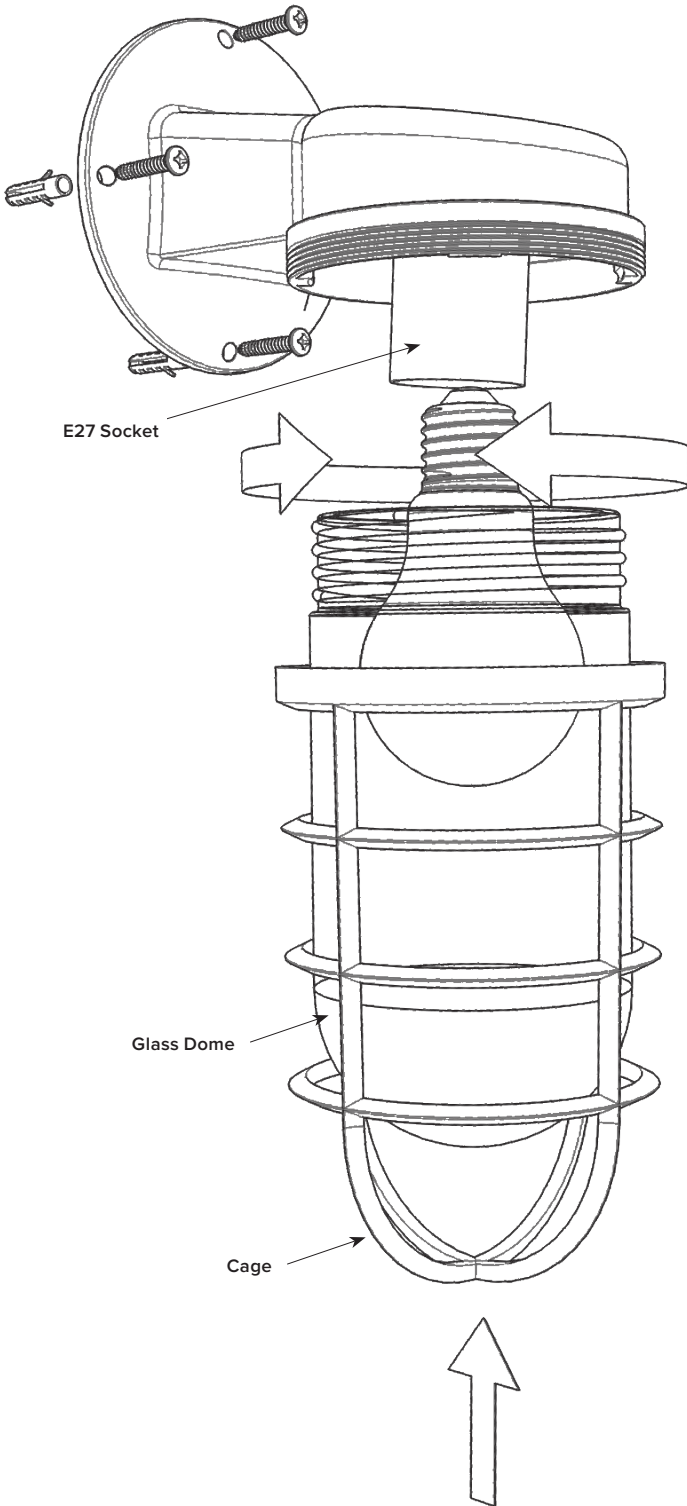

Connection Block Detail

FITTING INSTRUCTIONS

IMPORTANT: Electric current can kill. It is essential that this light is fitted by an experienced professional.

IMPORTANT: This light must be fixed to a secure structure from which it cannot become loose. We do not provide wall fixings as it is important that the correct fixing is chosen for your specific substrate.

IMPORTANT: This light is manufactured using traditional methods and moulds. Care must be taken when fitting this light to ensure it is not damaged. All of our products are individually checked before dispatch. You must inform us immediately on receipt of any damage otherwise your warranty made be effected.

Step 1: Turn off electric supply at board/consumer unit.

Step 2: Remove wall plate from Light Fitting by turning cage in the direction shown below. Be careful not to damage the glass dome in the process.

Step 3: Connect external supply to light cable on Wall Plate using the connection block provided. Please ensure correct connection of LIVE (L) TO LIVE (BROWN), NEUTRAL (N) TO NEUTRAL (BLUE) and \oplus EARTH TO EARTH (GREEN/YELLOW).

If you are fixing this Light Fitting in an external location or an area where the light's IP rating is critical to protect against water penetration, you need to ensure that your connection to the power supply is watertight.

Step 4: Fix Light Fitting to the wall through the Fixing Holes using suitable fixings the securely hold the weight of the light. Ensure light is secure.

Step 5: Fit LED bulb/lamp - E27, MAX 40W to the bulb holder in the light fitting.

Step 6: Carefully reassemble light with Glass Dome and Protective Cage, ensuring a tight seal is achieved with all fixings.

Step 7: Please dispose of packaging responsibly.

Additional information
can be found at sohlighting.com
or on request via email: info@sohlighting.com