

INSTRUCTIONS

LT-SH-10-WLT206 (all finishes)

Bulb Fitting: E27, Max. 40W, 220-240V~50Hz

IMPORTANT! Please read these instructions fully before attempting to fit this product.

WARNING: ENSURE THE ELECTRICAL SUPPLY TO THE WIRES YOU ARE WORKING ON IS SHUT OFF COMPLETELY; EITHER BY REMOVING THE FUSE OR TURNING OFF THE CIRCUIT BREAKER. TURNING THE POWER OFF USING THE LIGHT SWITCH IS INSUFFICIENT PROTECTION AGAINST ELECTRIC SHOCK.

NOTE: These important safeguards and instructions are not meant to cover all possible conditions or situations that may occur. It must be understood that common sense, caution, and care, are factors that must be supplied by the person(s) installing this product.

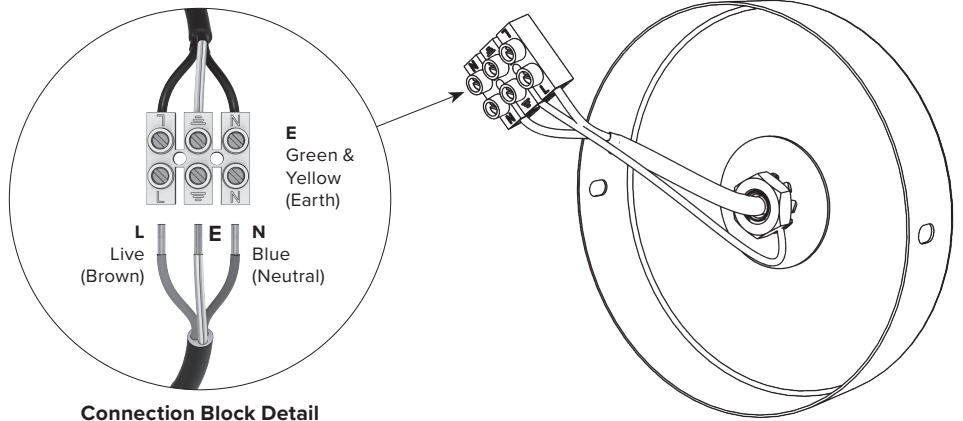

IMPORTANT: Electric current can kill, always turn off the electricity supply before fitting. It is essential that this light is fitted by an experienced professional.

IMPORTANT: This light must be fixed to a secure structure that will safely bear its weight and from which it cannot become loose. The supplied fixings will not be suitable for all situations, please ensure you use the correct fixings for your building fabric.

IMPORTANT: Please dispose of packaging responsibly.

Connection Block Detail

Rose Internal View

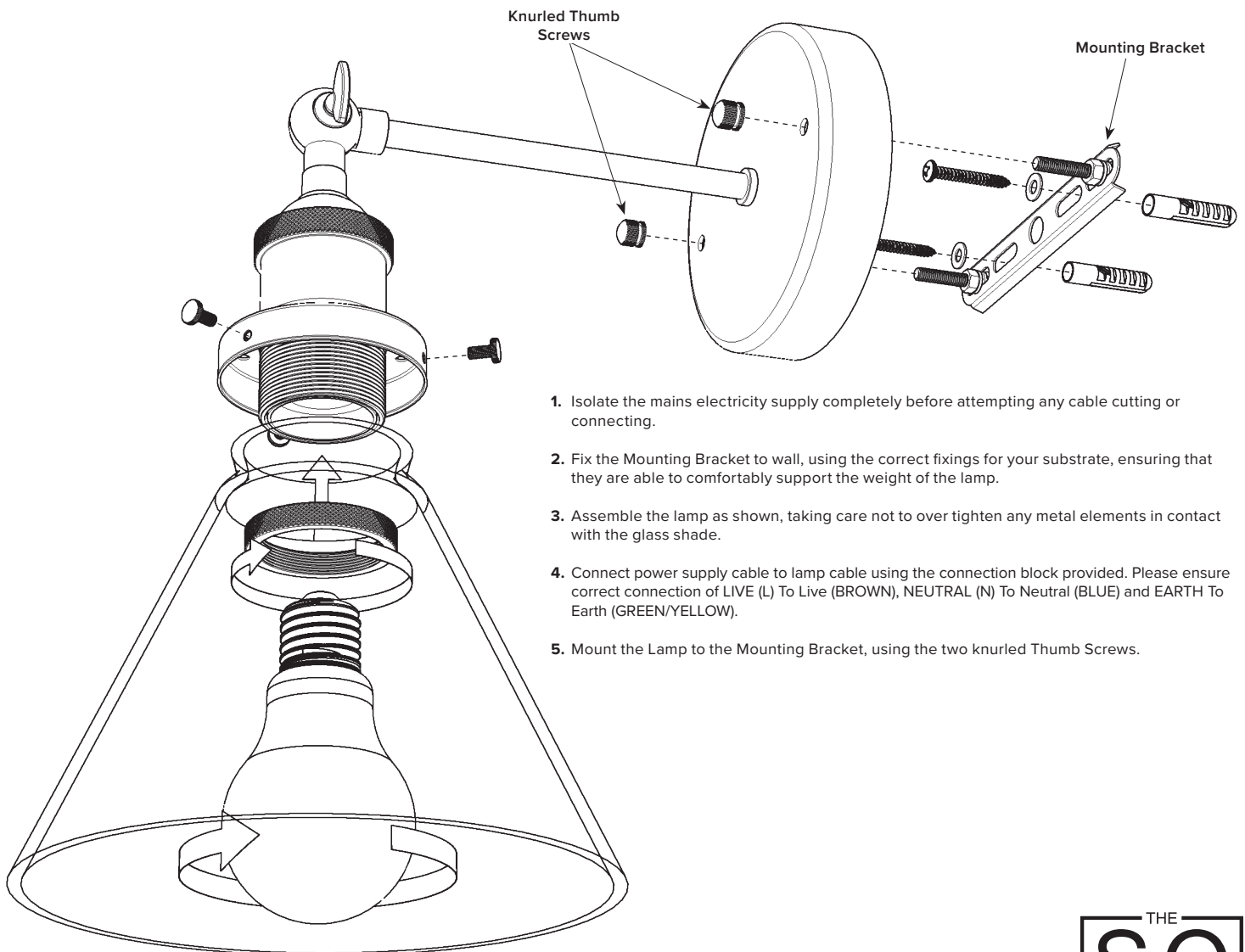

1. Isolate the mains electricity supply completely before attempting any cable cutting or connecting.
2. Fix the Mounting Bracket to wall, using the correct fixings for your substrate, ensuring that they are able to comfortably support the weight of the lamp.
3. Assemble the lamp as shown, taking care not to over tighten any metal elements in contact with the glass shade.
4. Connect power supply cable to lamp cable using the connection block provided. Please ensure correct connection of LIVE (L) To Live (BROWN), NEUTRAL (N) To Neutral (BLUE) and EARTH To Earth (GREEN/YELLOW).
5. Mount the Lamp to the Mounting Bracket, using the two knurled Thumb Screws.

Additional information
can be found at sohlighting.com
or on request via email: info@sohlighting.com